

# **ELIAS Grammar Test**

## **Version A**

Kristin Kersten, Thorsten Piske, Andreas Rohde, Anja Steinlen, Martina Weitz  
Pictures: Susanne Kurth



**Early Language and Intercultural Acquisition Studies**  
Multilateral Comenius Project funded by the European Commission

## Prompts Version A

1. SVO
2. PLURAL -S
3. PRONOUN (OBJECT)
4. POSSESSIVE DETERMINER (M/F)
5. NEGATION
6. 3<sup>rd</sup> PERSON SINGULAR -S
7. COPULAR VERBS
8. POSSESSIVE VS OBJECT
9. PRO M/F SG

## "Show me ..."

- dog** (Training)
- cat** (Training)
- i. **the boy is touching the girl** (SVO)
- i. **cats** (Pl -s)
- i. **the girl is kissing her** (Pro Obj)
- i. **his cat** (Poss)
- i. **the boy is not running** (Neg)
- i. **the sheep eats** (3Sg)
- i. **the deer are white** (Cop)
- i. **the girl is kissing the boy** (Poss Obj)
- i. **he is singing** (Pro)
- ii. **the dog is chasing the cat** (SVO)
- ii. **pen** (Pl -s)
- ii. **the father is chasing him** (Pro Obj)
- ii. **her apple** (Poss)
- ii. **the dog is sleeping** (Neg)
- ii. **the fish jump** (3Sg)
- ii. **the fish is black** (Cop)
- ii. **the girl is feeding the boy's dog** (Poss Obj)
- ii. **she is drinking** (Pro)
- iii. **the fish is kissing the frog** (SVO)
- iii. **balls** (Pl -s)
- iii. **the mother is touching her** (Pro Obj)
- iii. **his ball** (Poss)
- iii. **the duck is not eating** (Neg)
- iii. **the reindeer sleeps** (3Sg)
- iii. **the sheep are happy** (Cop)
- iii. **the girl is carrying the boy** (Poss Obj)
- iii. **he is running** (Pro)

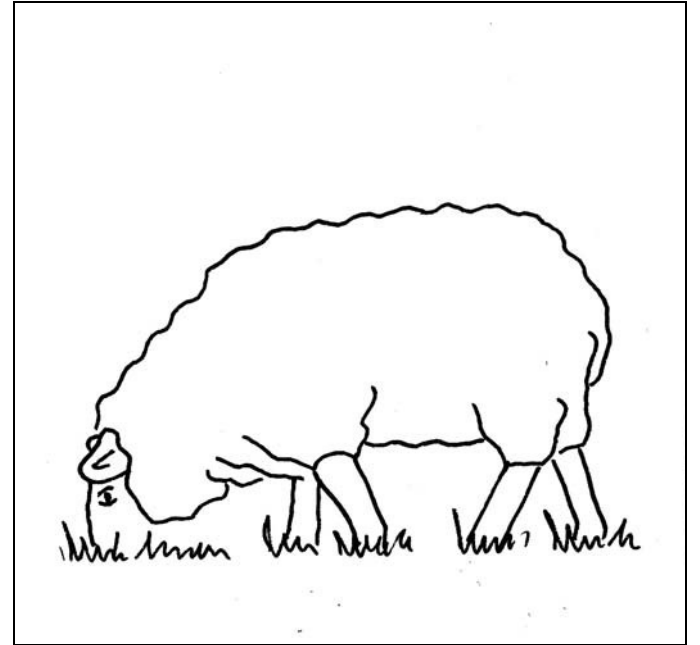
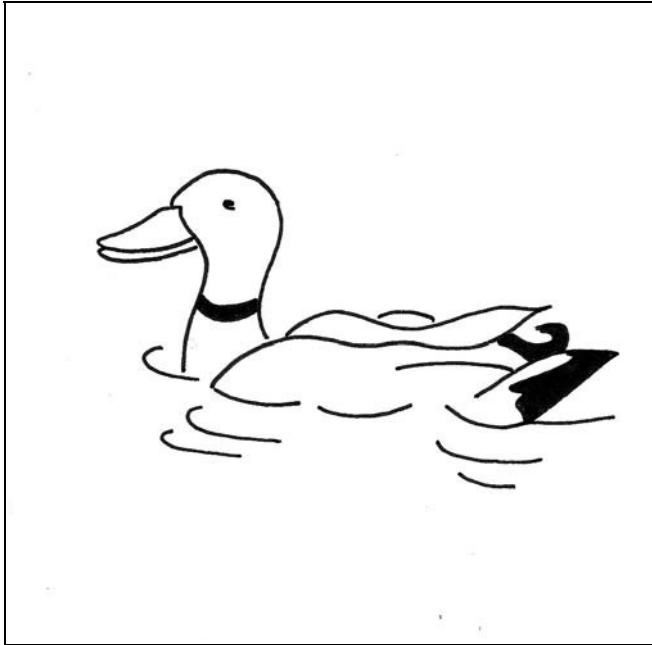
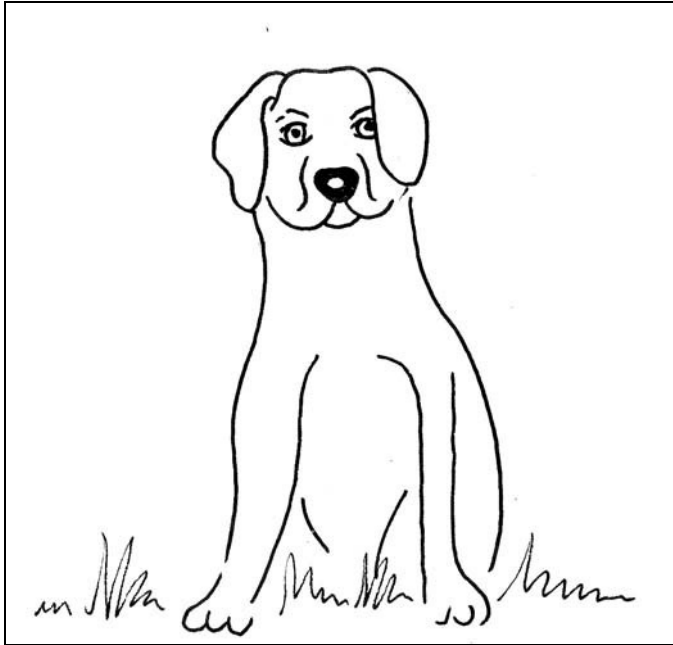

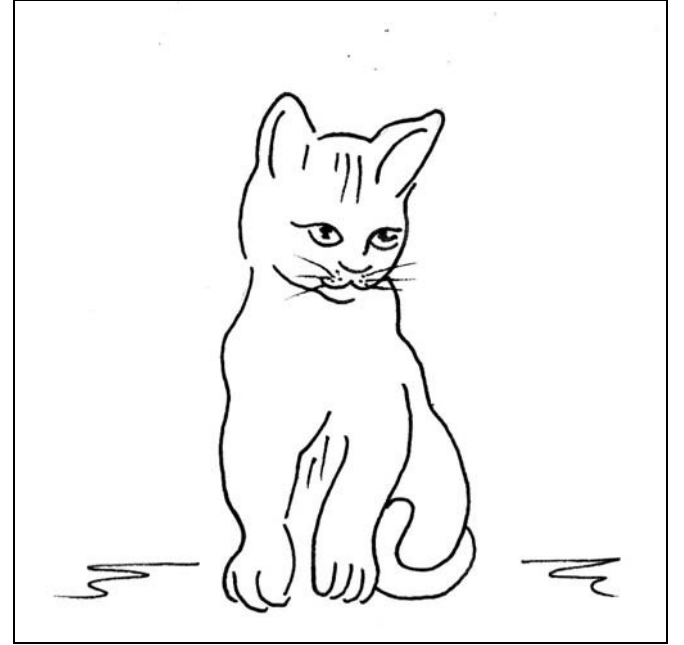
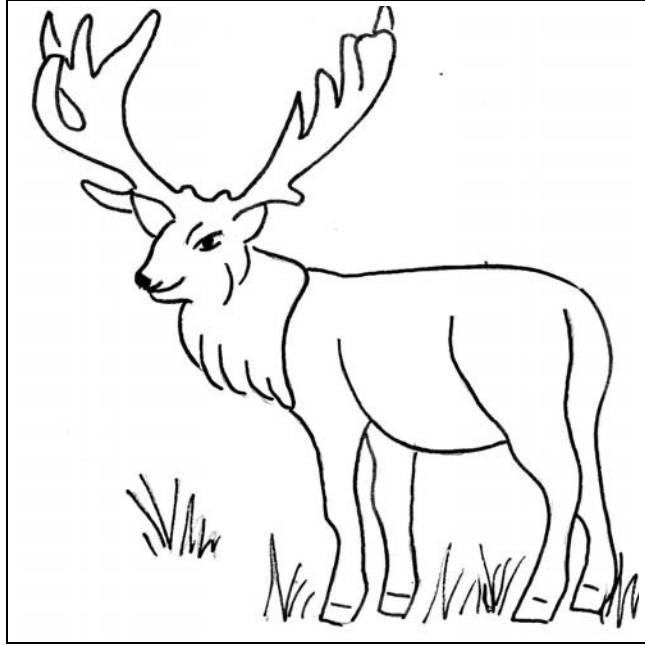
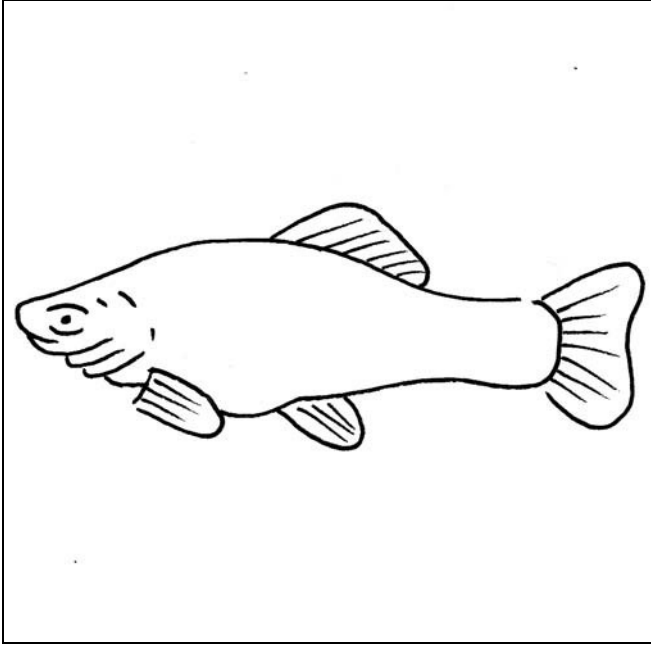

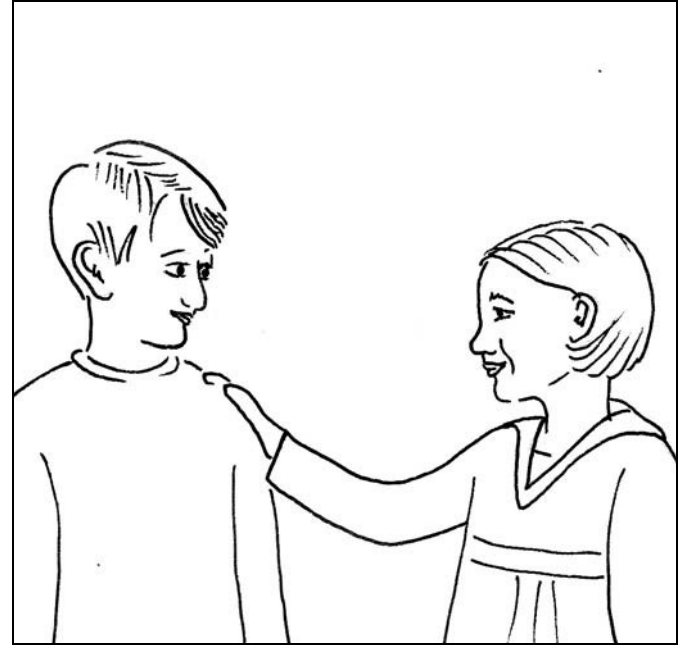
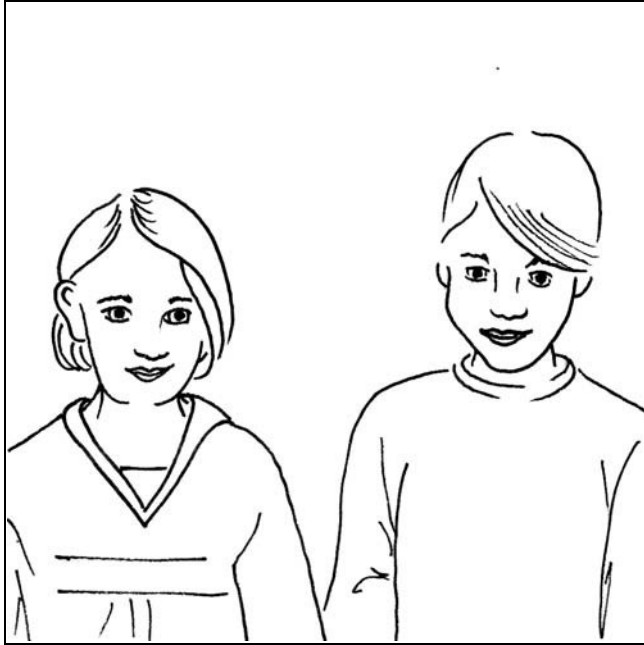
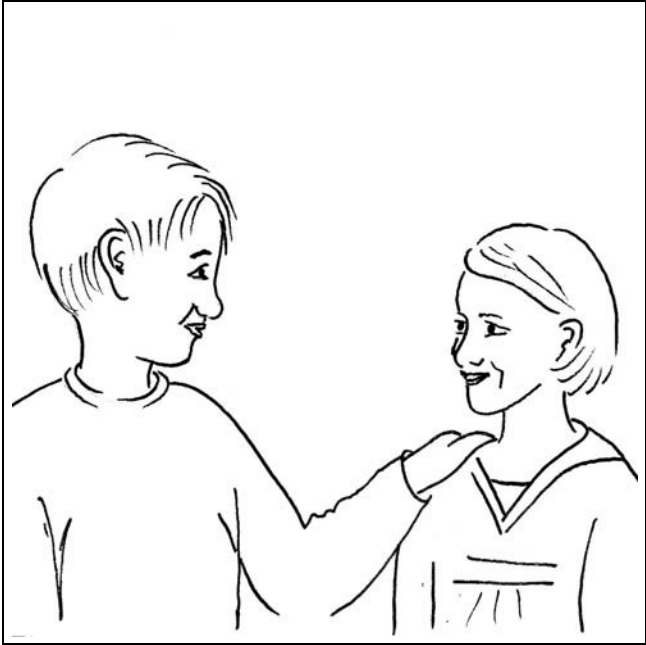

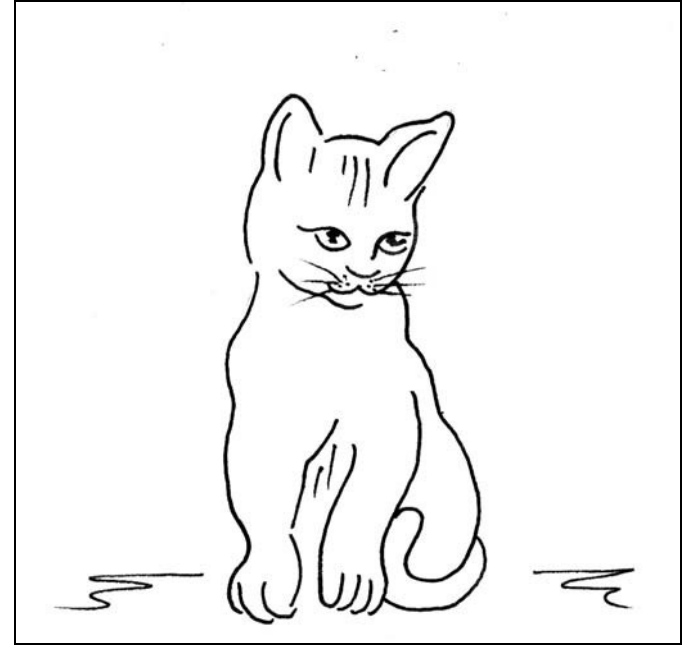
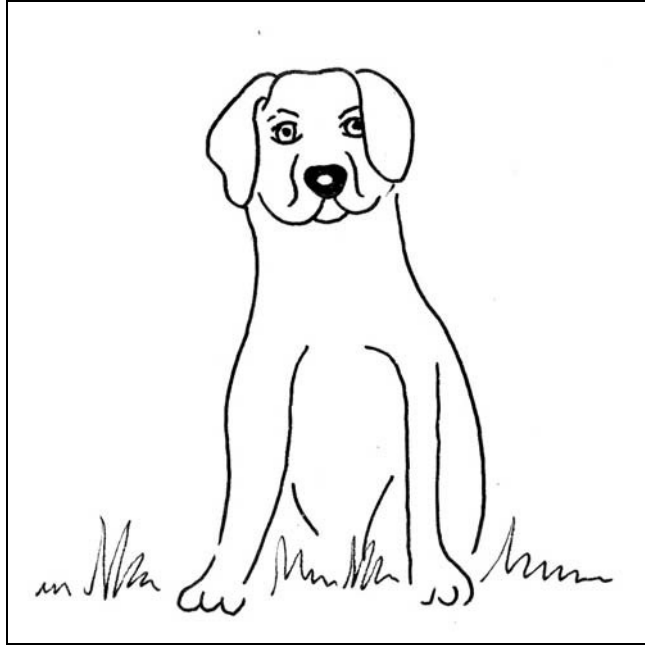
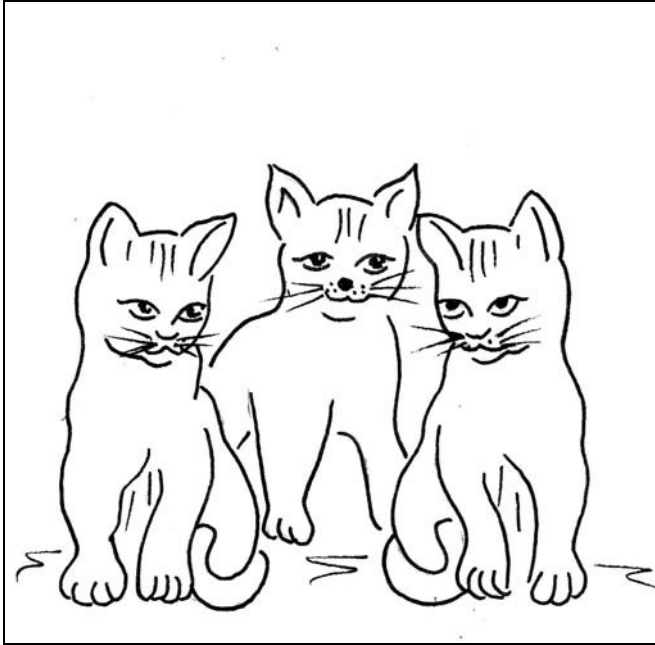



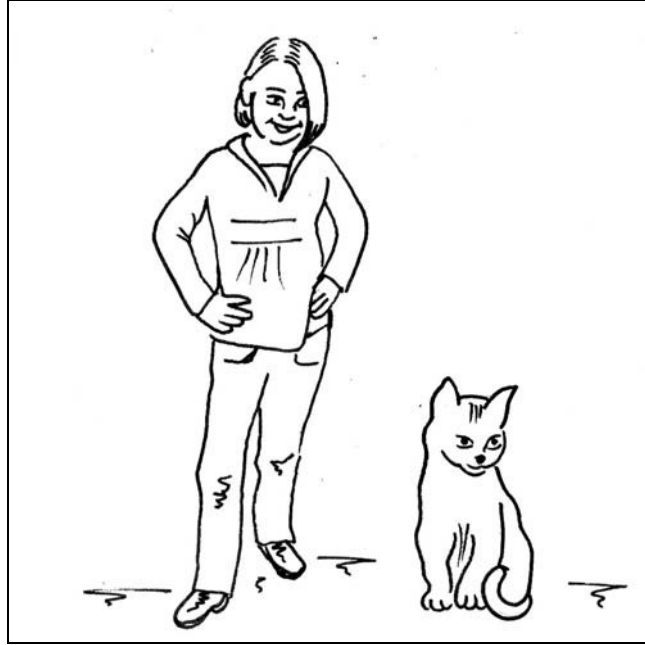
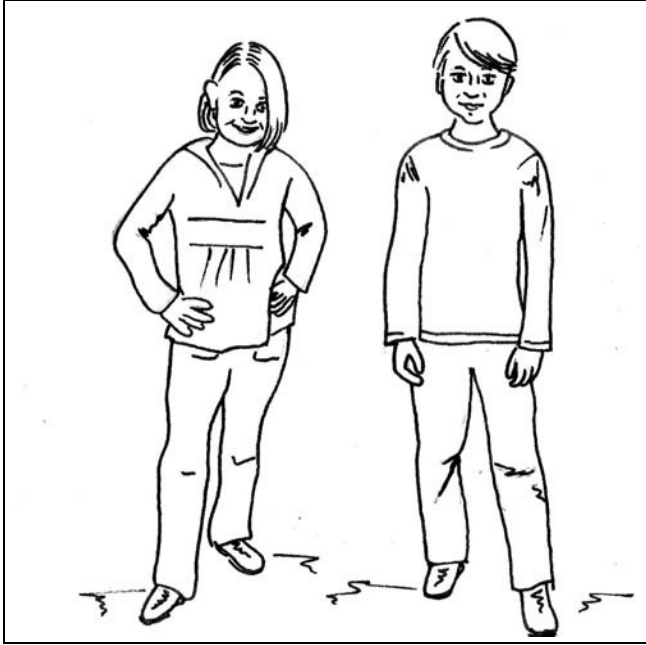





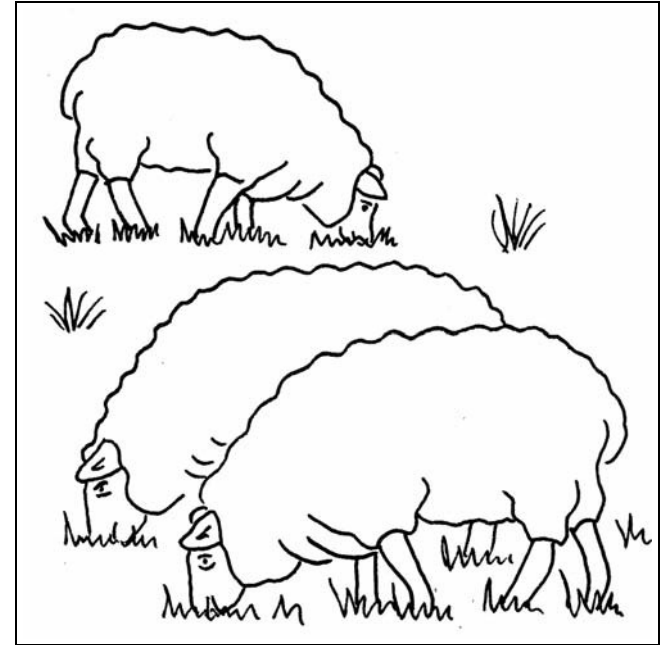
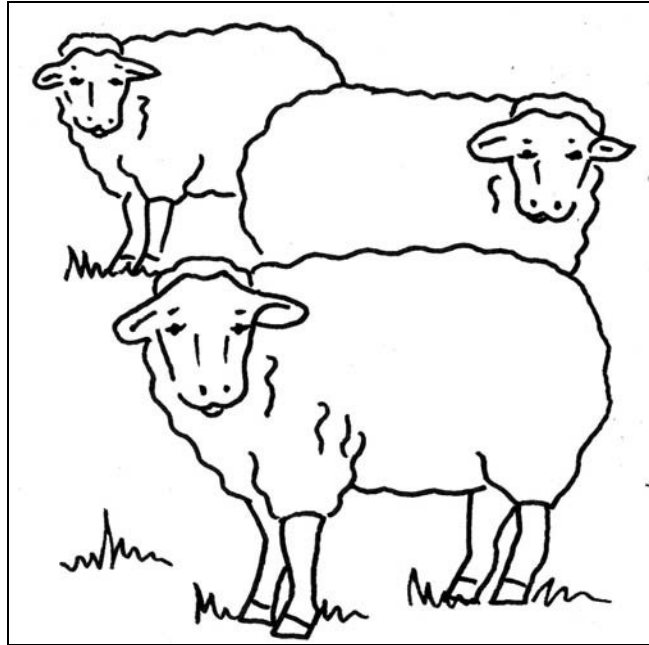
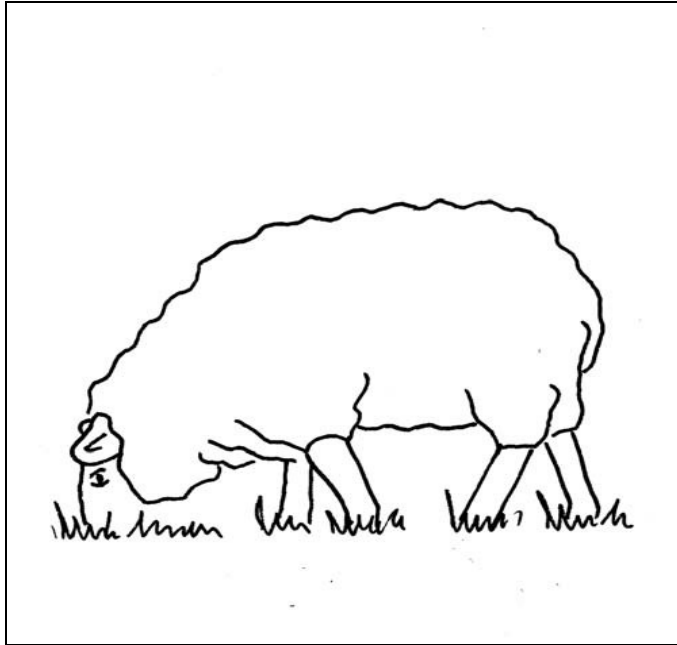

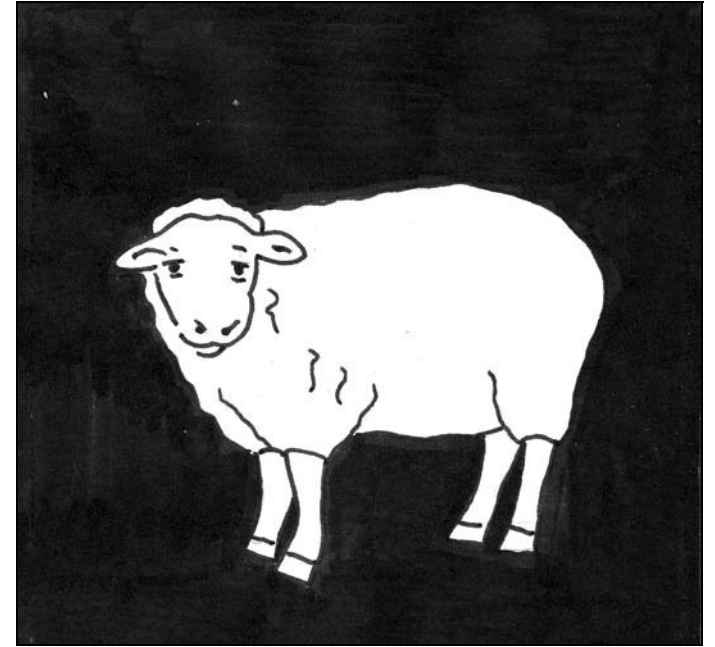
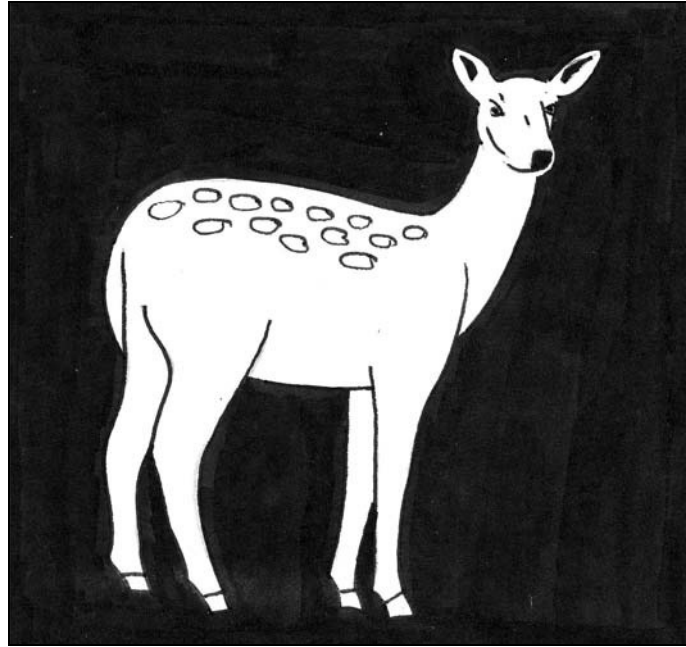
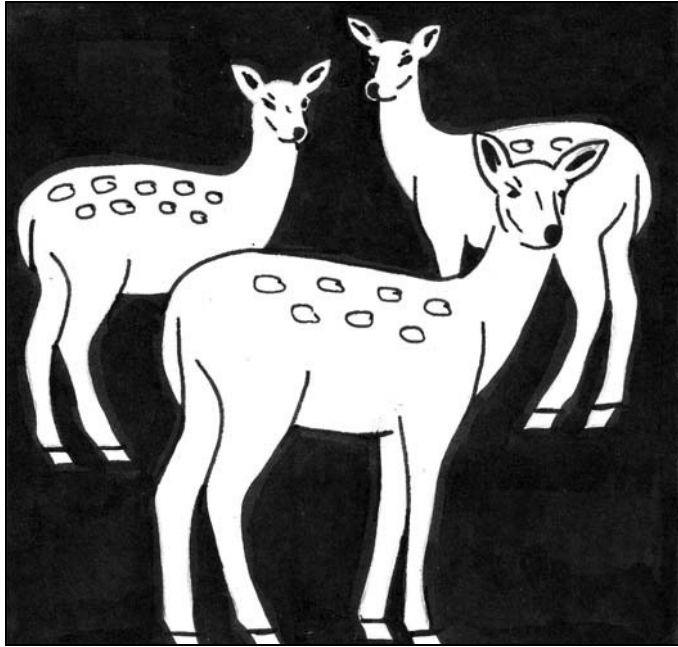





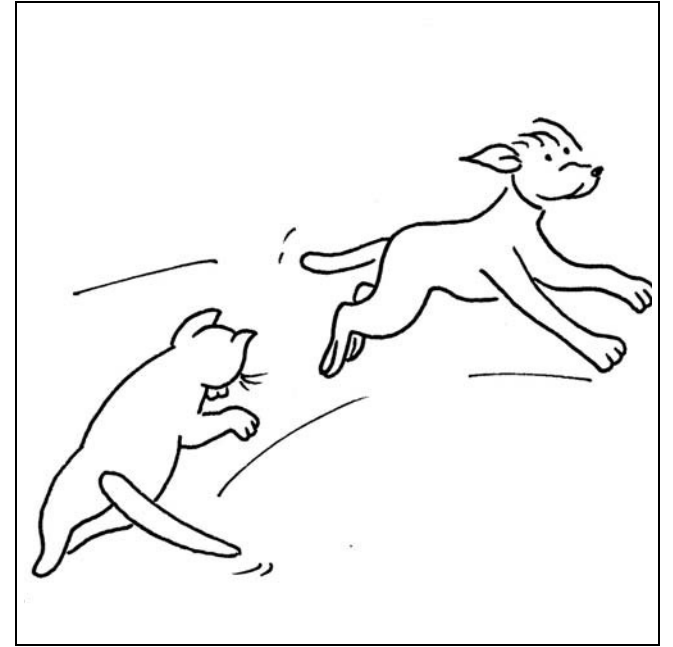
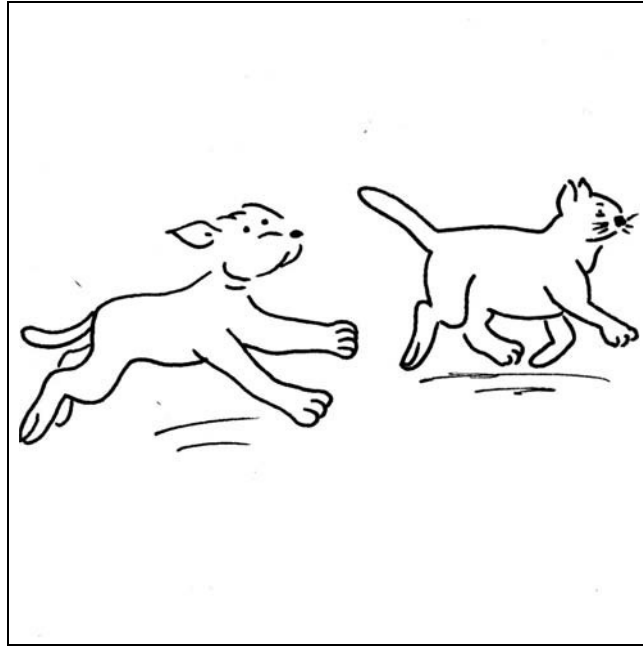
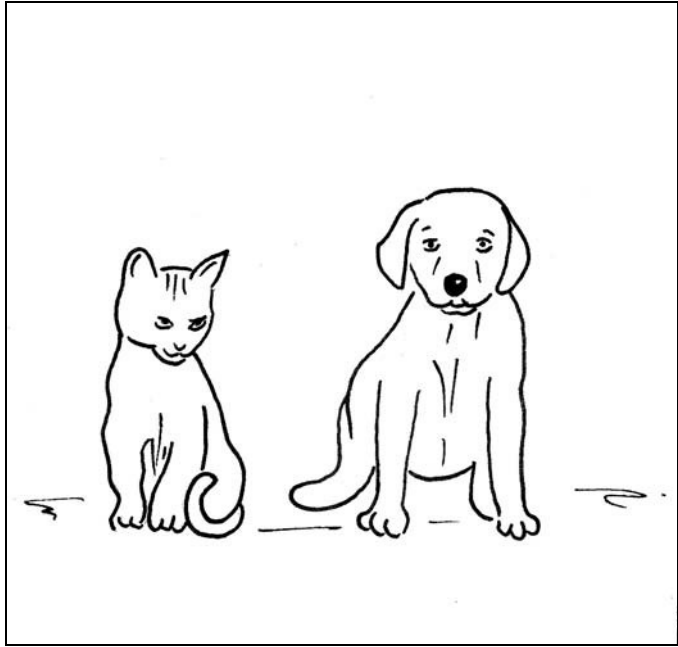

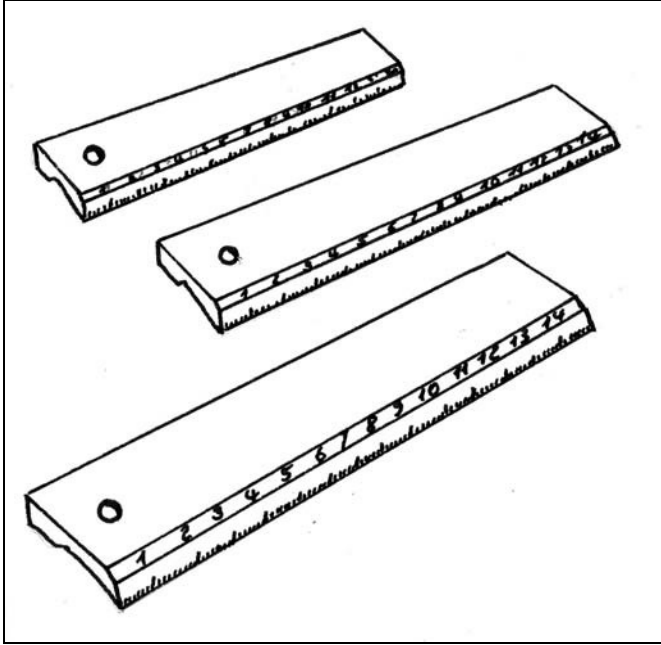

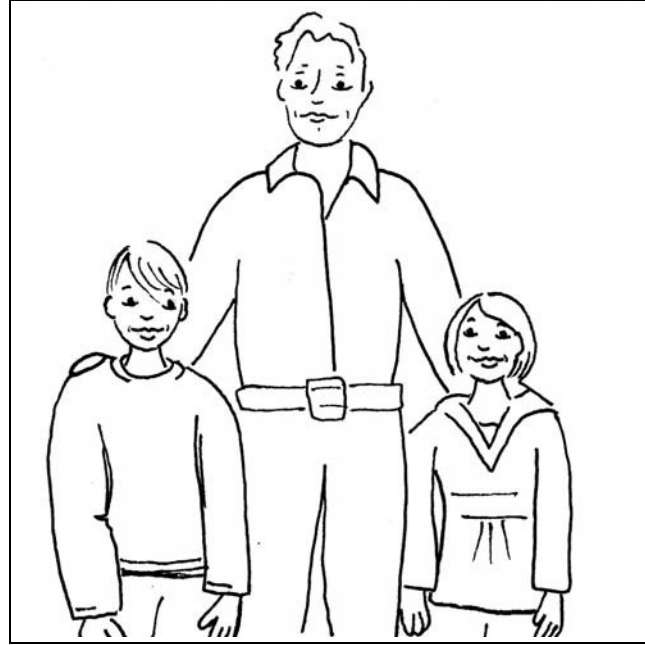



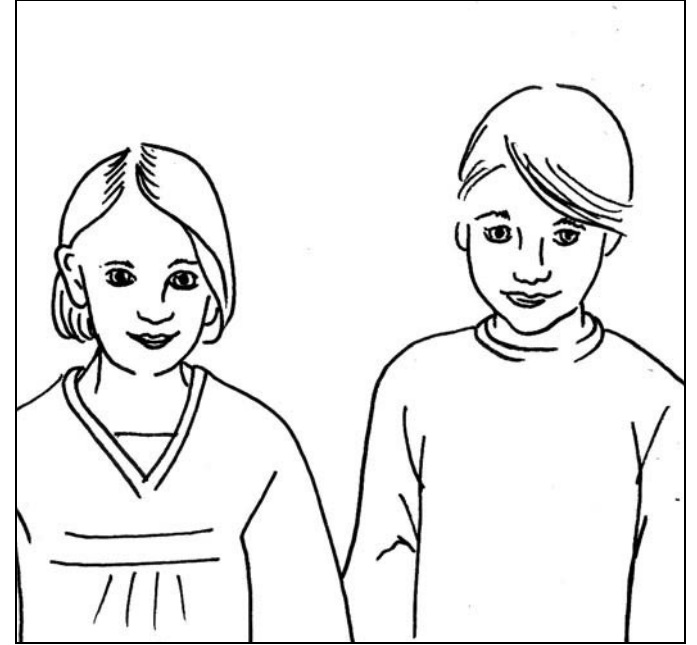
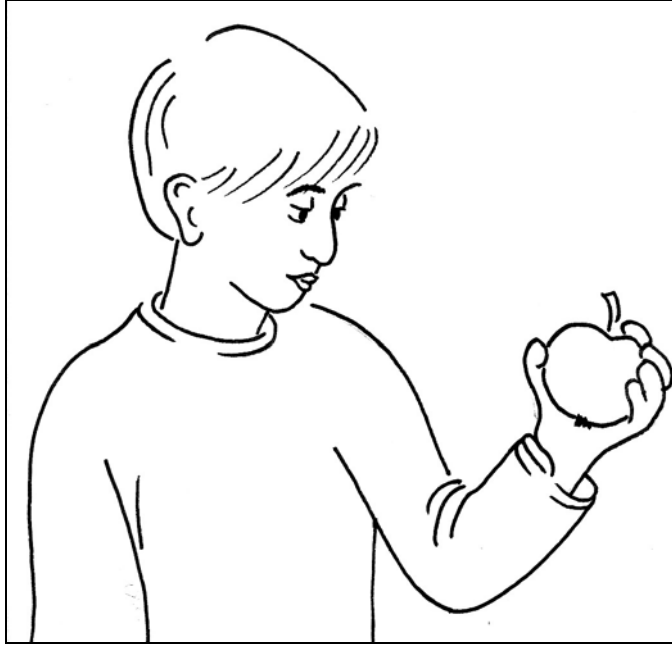
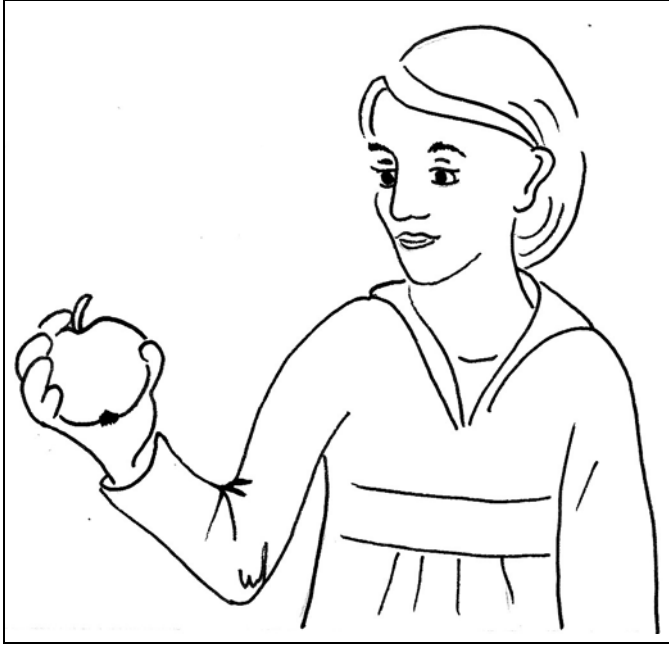

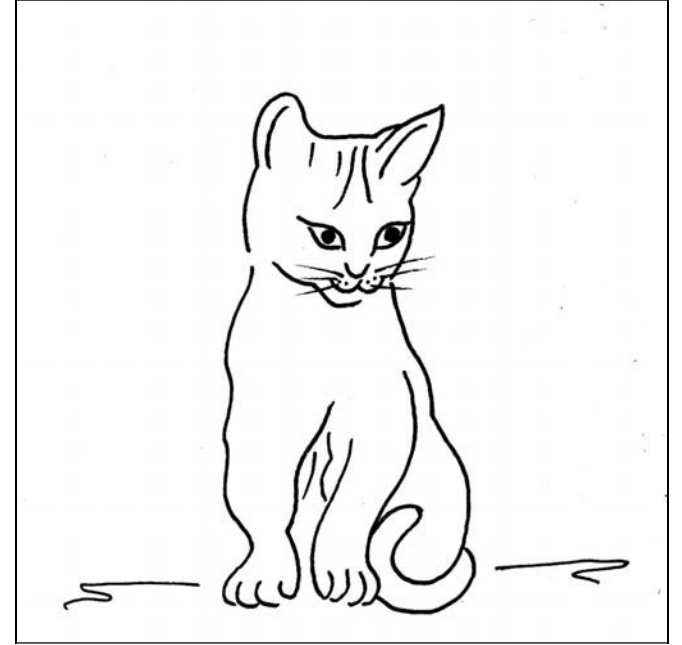
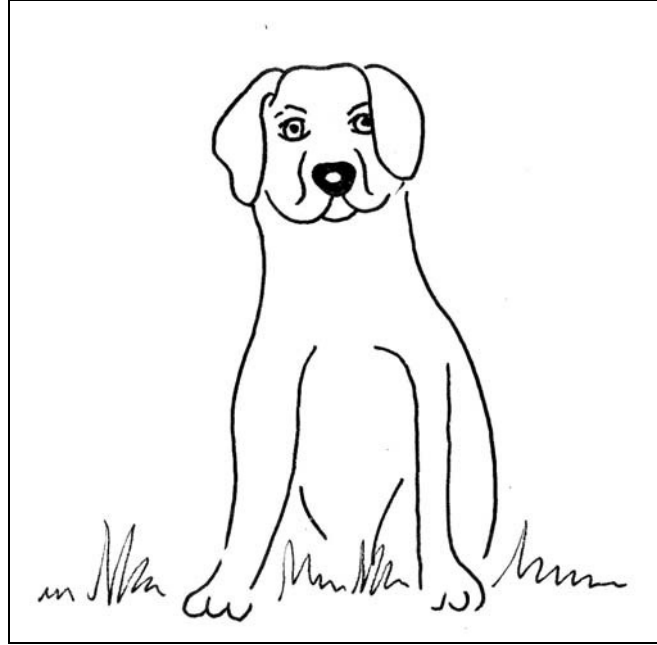
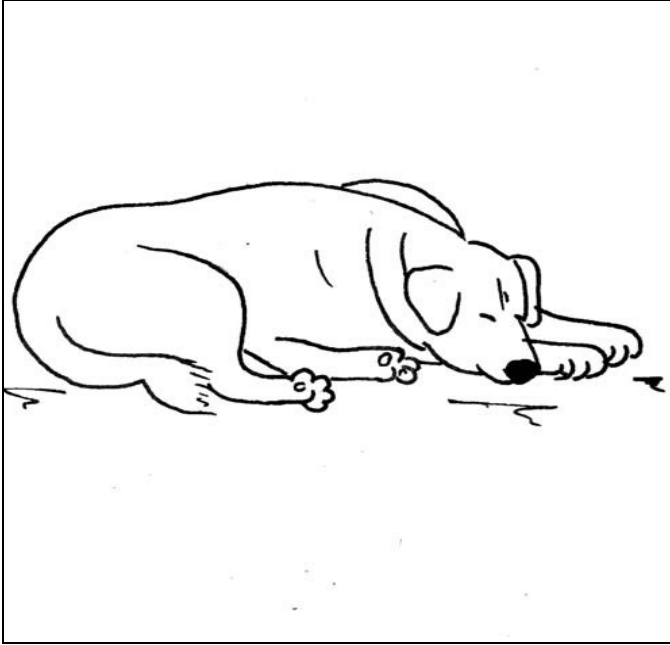

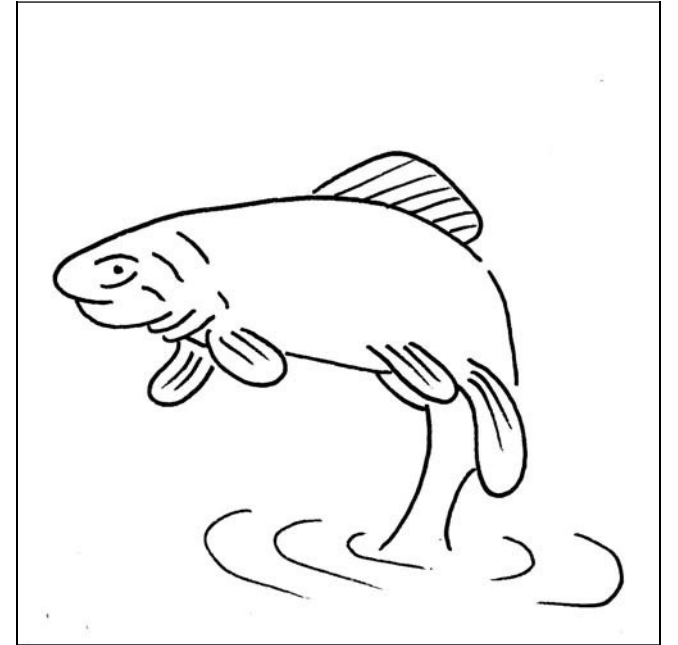
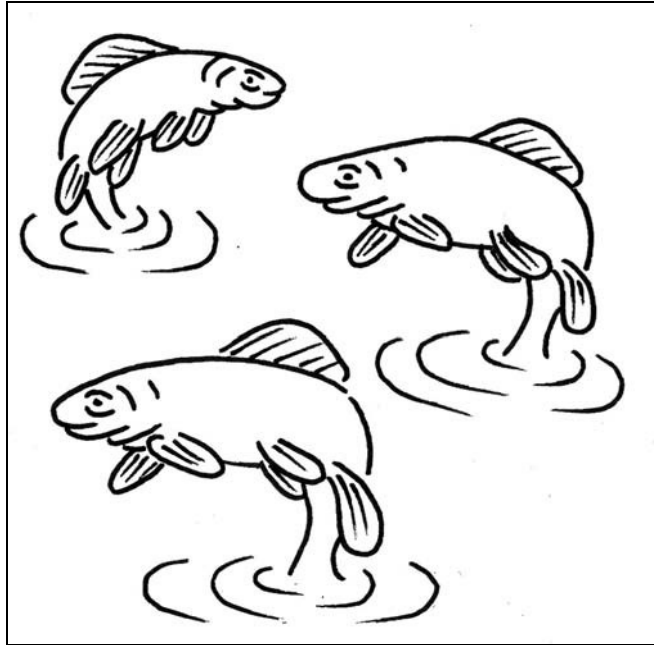
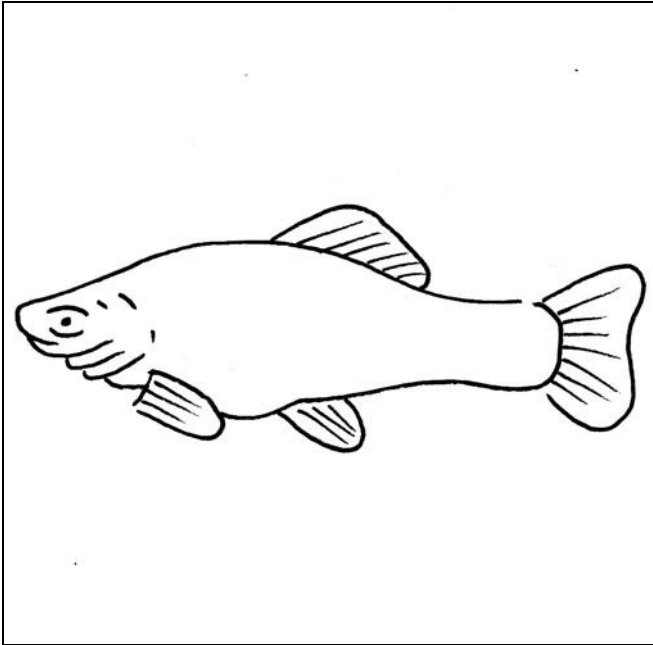

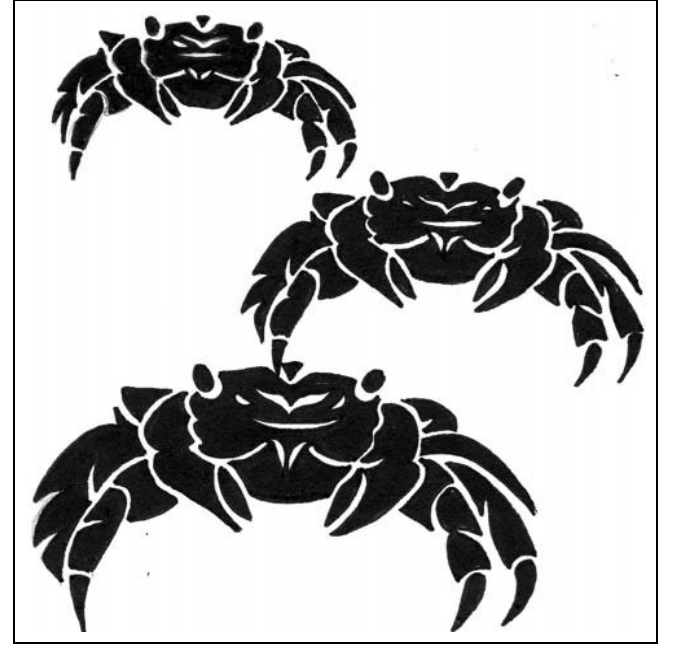
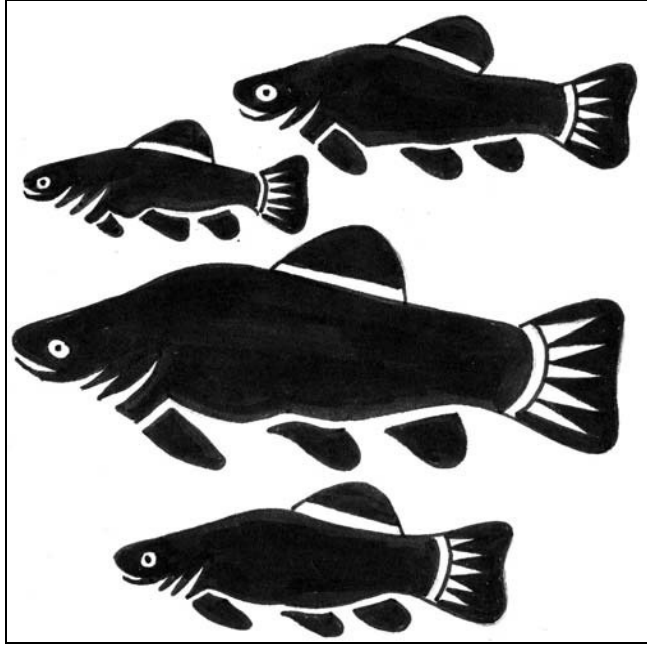
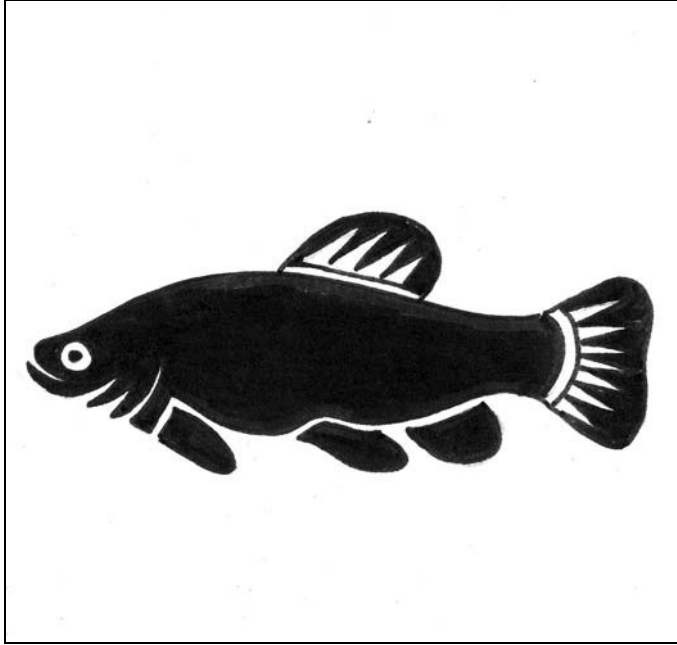

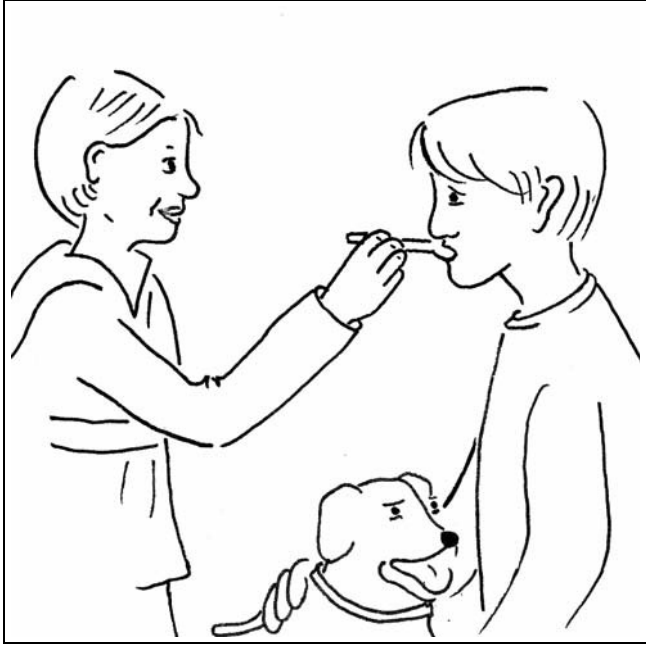



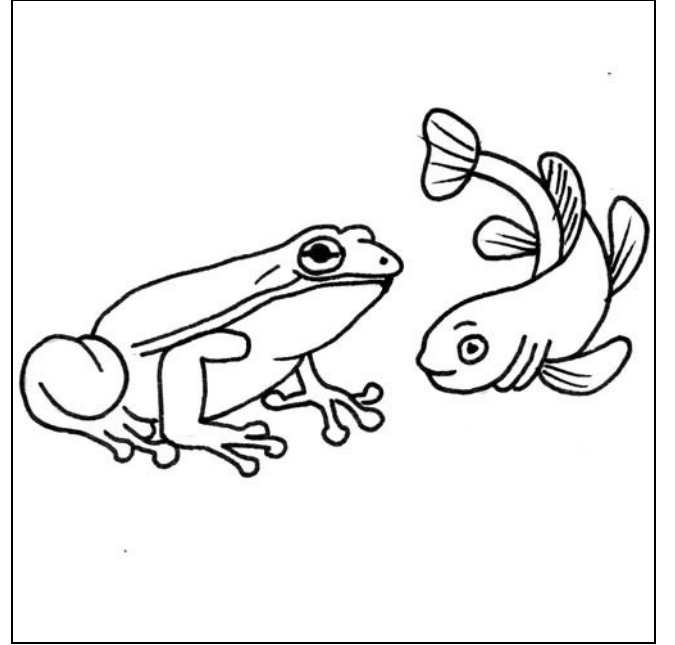
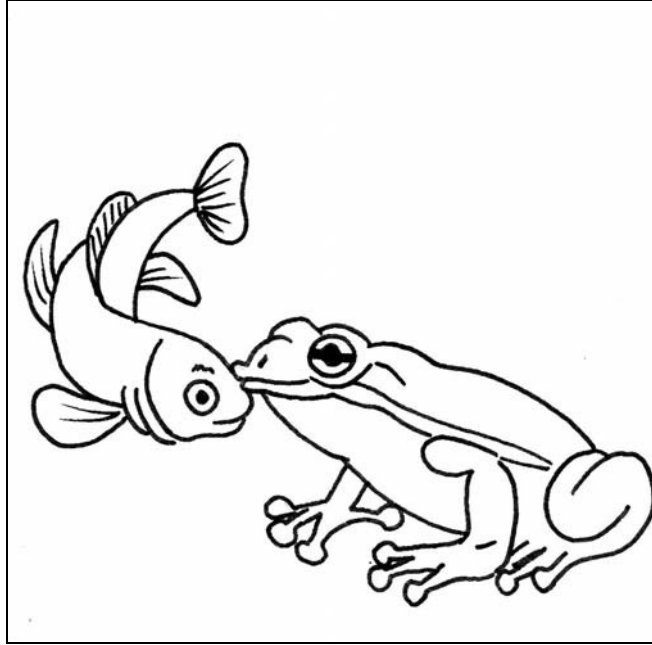
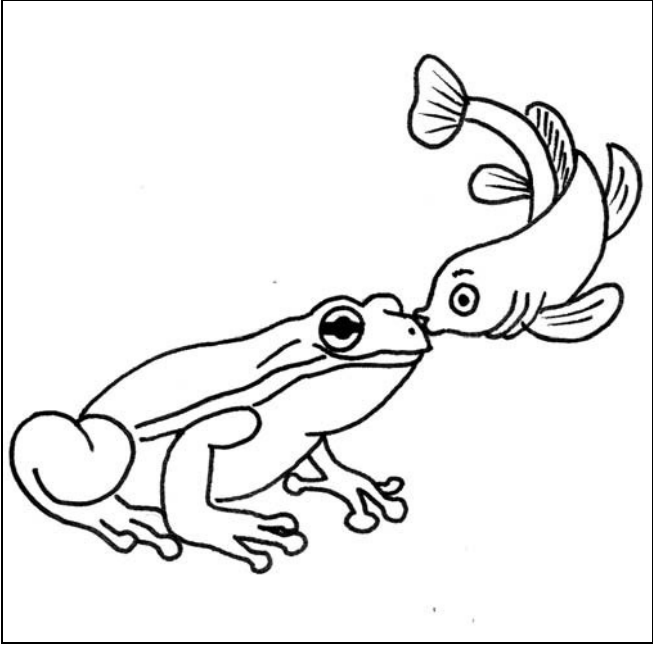

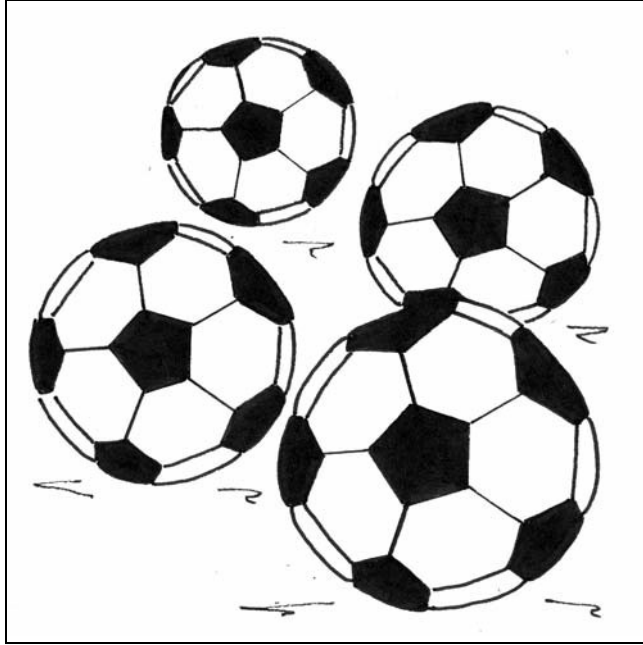
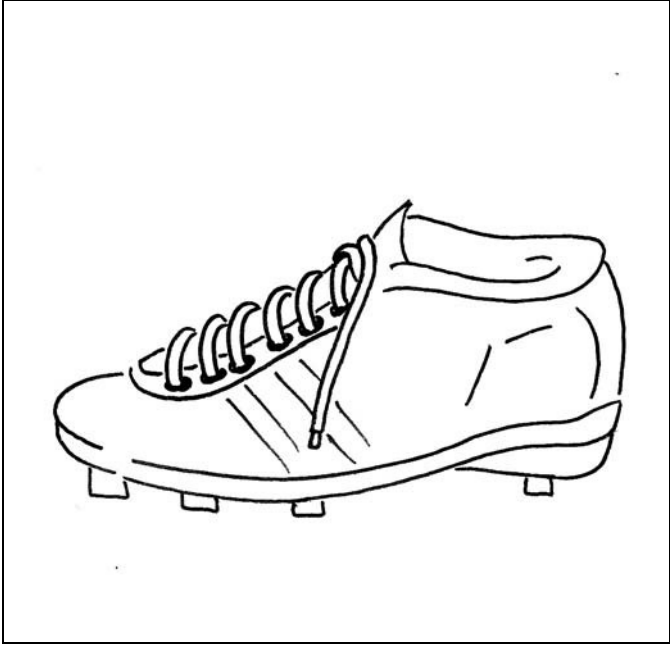



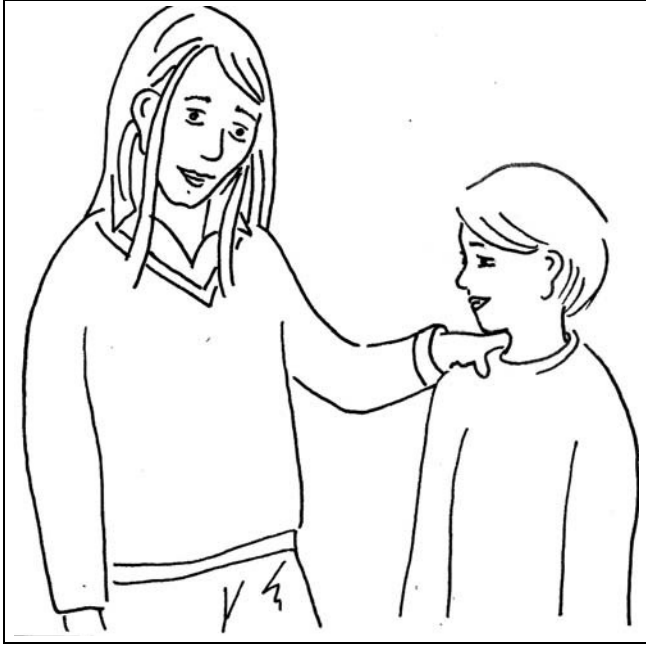

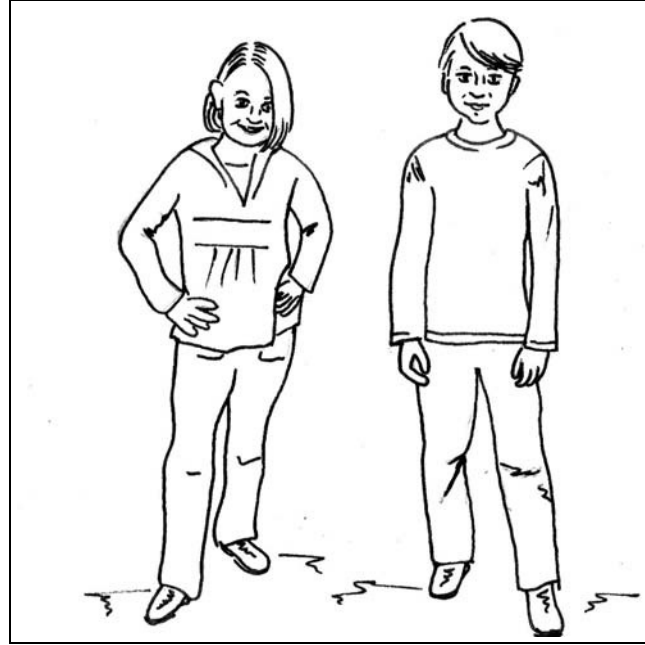

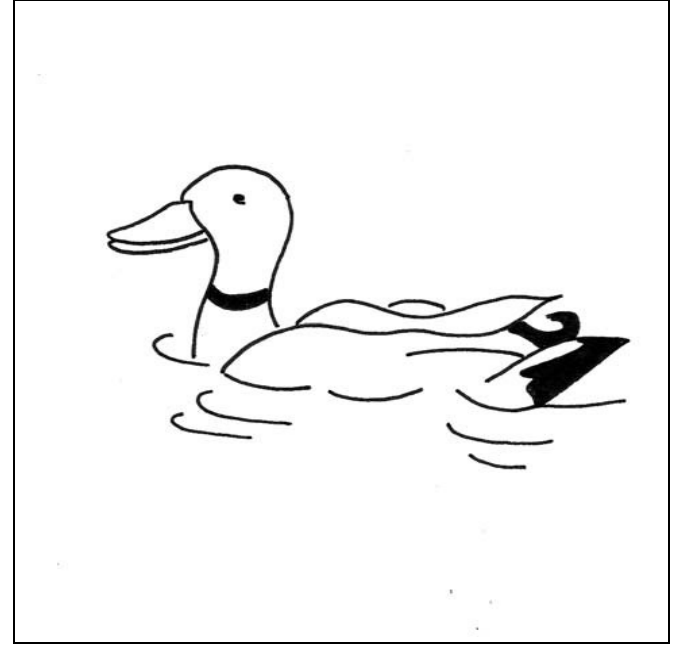
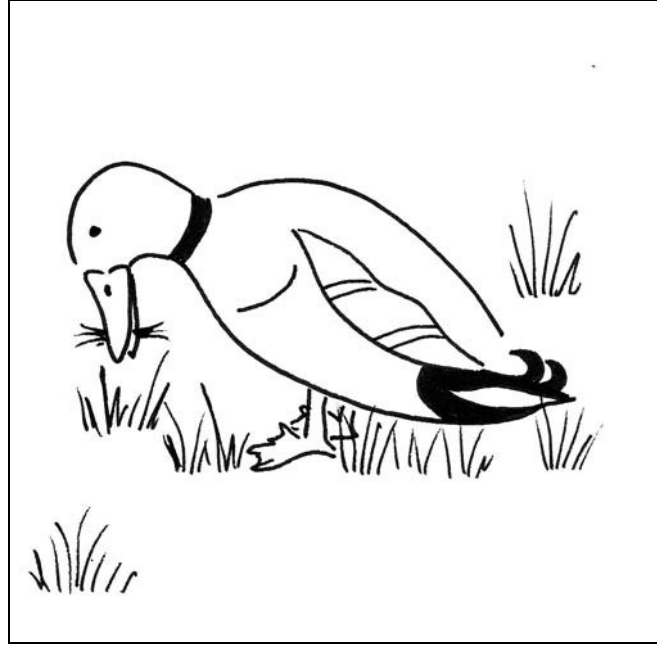
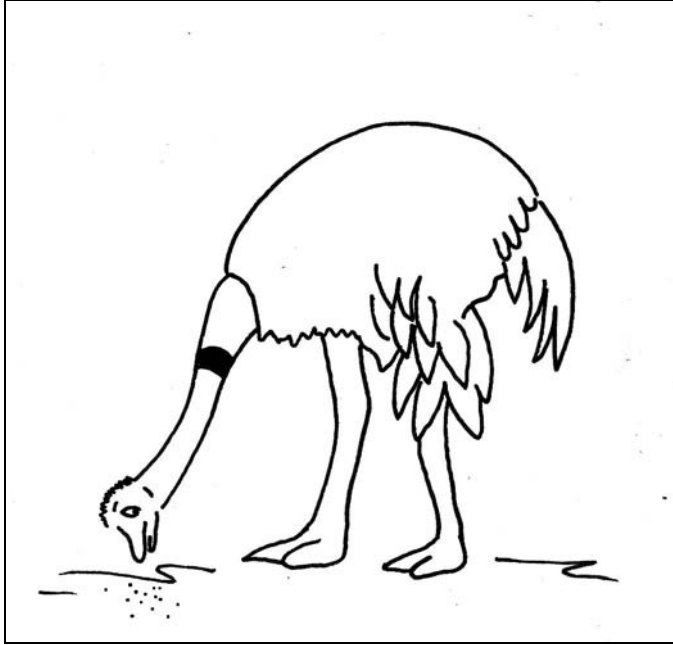

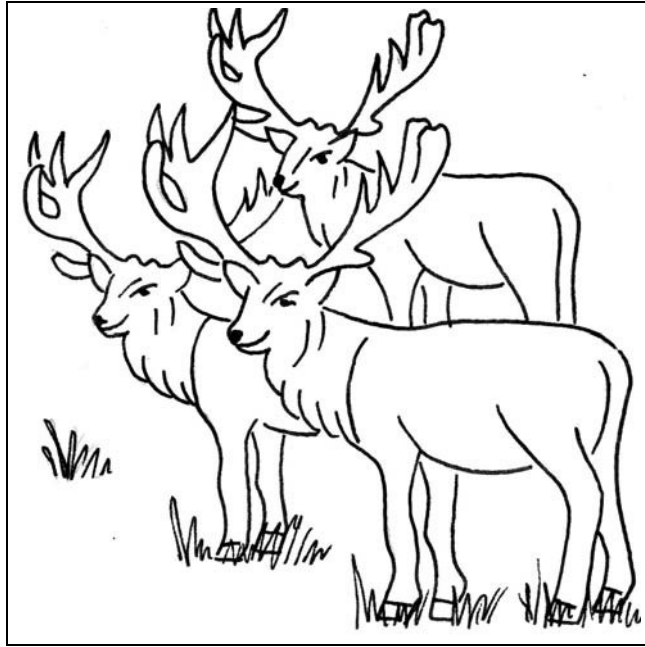

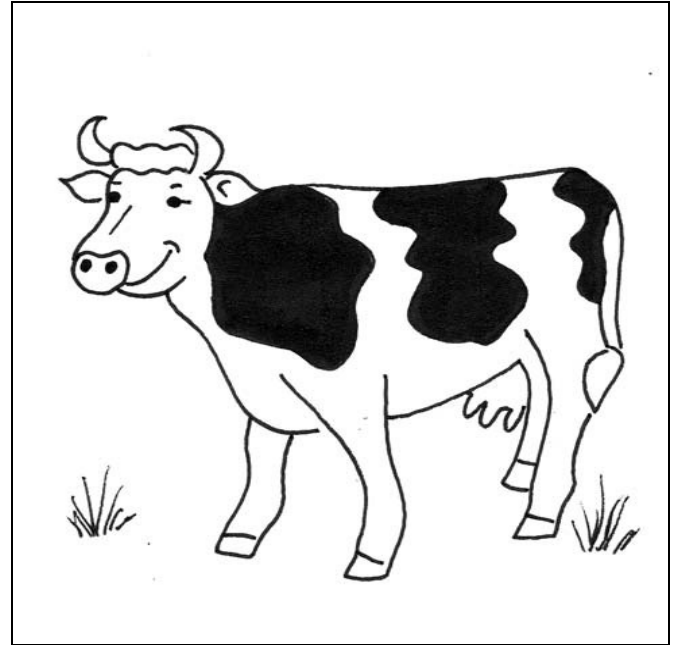
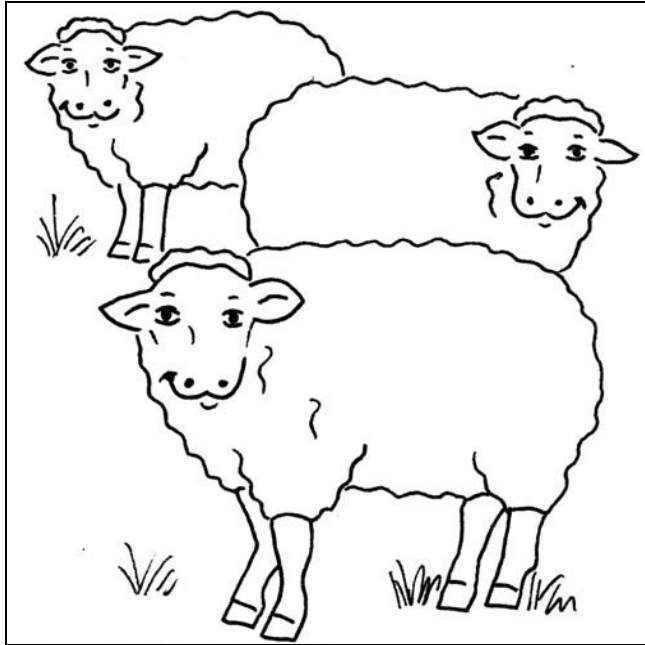
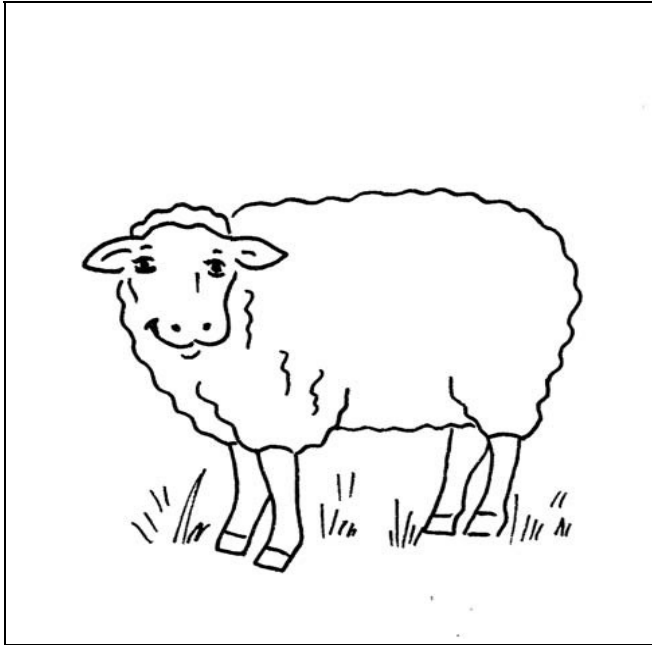

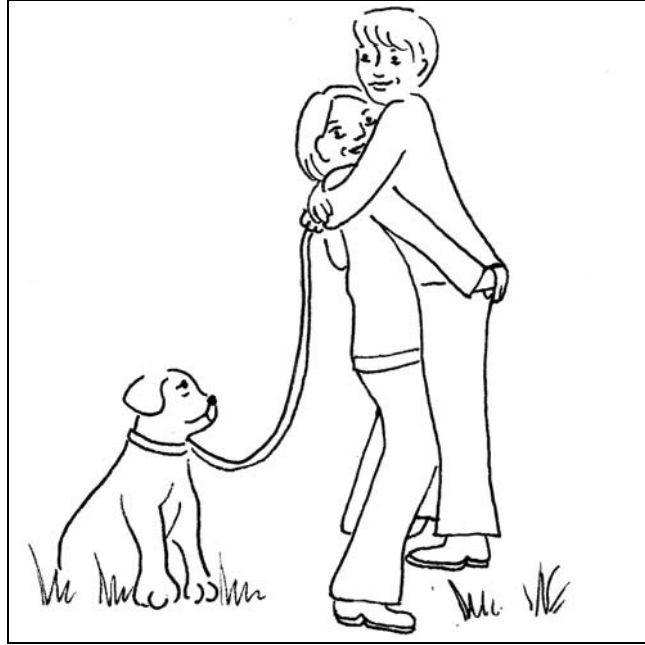

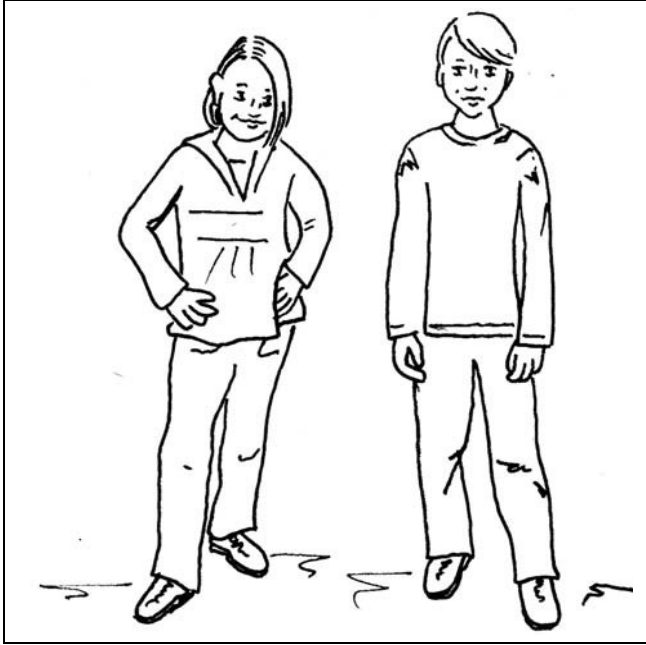



**The ELIAS project has been funded with support from the European Commission.**

**Disclaimer:**

This product reflects the views only of the authors, and the Commission cannot be held responsible for any use which may be made of the information contained therein.

Grant Agreement Number: 2008 - 3378 / 001 - 001

